

# Technical Manual

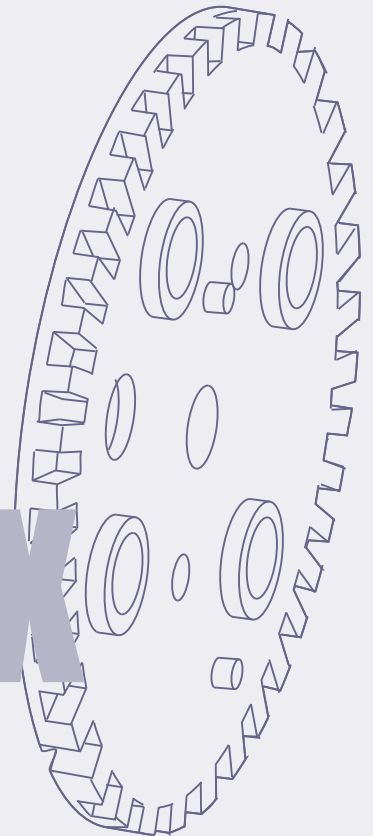

# NEMA 4X

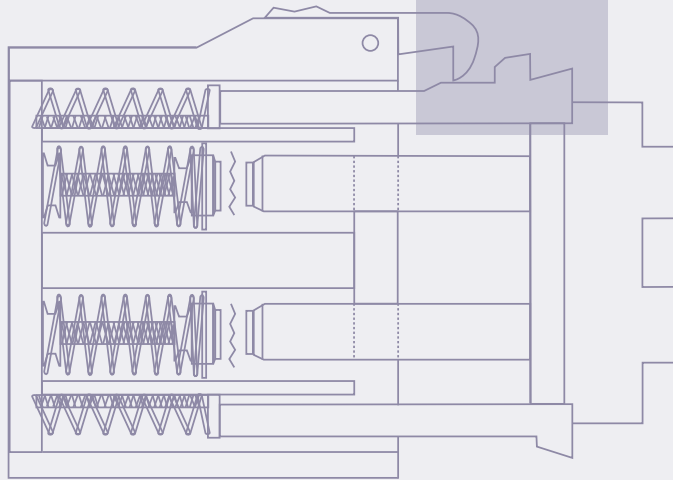
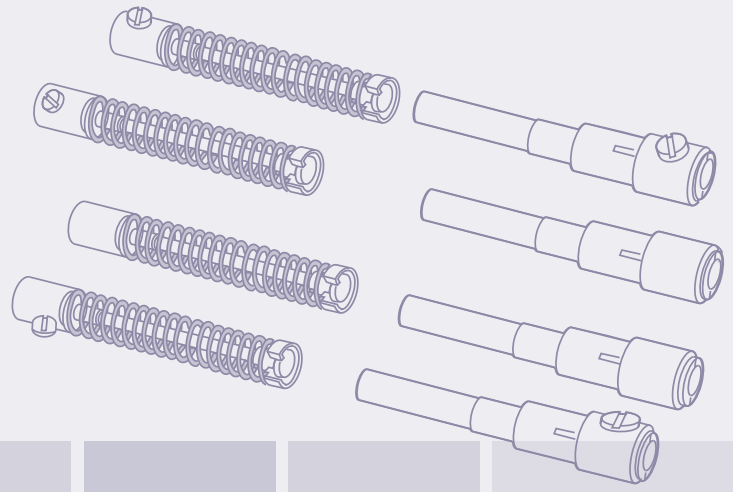

# Technical Manual

<b>Switch Ratings vs Current Interrupting Ratings</b>	<b>p. 183</b>
<b>Electrical Performance</b>	<b>p. 184</b>
<b>Butt-Contact Technology</b>	<b>p. 187</b>
<b>Dead-Front Construction</b>	<b>p. 189</b>
<b>Keying System</b>	<b>p. 190</b>
<b>Dual Voltage Devices</b>	<b>p. 190</b>
<b>Resistance to Environments and Chemicals</b>	<b>p. 191</b>
<b>Watertightness/Ingress Protection</b>	<b>p. 193</b>
<b>Impact Resistance</b>	<b>p. 194</b>
<b>Operating Temperatures</b>	<b>p. 194</b>
<b>Color-Coded Gaskets &amp; Labels</b>	<b>p. 195</b>

# Electrical Performance – Switch Rated, Current Interrupting Rated and Non-Current Interrupting Rated Devices

## Switch Rated Plugs & Receptacles

Meltric's DECONTACTOR™ Series products are UL & CSA listed as switch rated plugs and receptacles. These ratings allow them to be used as a motor circuit disconnect switch, as well as a branch circuit disconnect switch. Switch rated plugs and receptacles have passed electrical overload, short circuit and endurance tests that are far more rigorous than those applied to other plugs and receptacles. These tests include the functional requirements for safety disconnect switches in addition to manual motor controllers. For more information about the tested electrical performance of switch rated devices consult pages 184 - 186.

## Current Interrupting Rated Plugs & Receptacles

Other Meltric devices such as the DXN plugs and receptacles are UL and CSA rated for “current interrupting”. A current interrupting rated plug and receptacle is not subjected to the same level of endurance testing as a switch rated device and does not need to be subjected to any overload-locked rotor or short circuit testing (see pages 184 - 186 for performance test comparisons). Plug and receptacles rated for “current interrupting” are not intended to be used as switches, but can withstand making and breaking of normal resistive loads. Devices that are not hp and short circuit rated are not intended to make and break motor loads or other inductive loads.

## Non-Current Interrupting Rated Plugs & Receptacles

Many competitive plugs and receptacles, as well as some Meltric devices are “non-current interrupting” rated. They are not approved by UL or CSA for connecting or disconnecting under load. They have passed the minimum test requirements for plugs and receptacles but they have not passed current interrupting performance tests or the more demanding electrical endurance, overload and short circuit tests required of switch rated devices. For more information about the tested electrical performance of non-current interrupting rated devices consult pages 184 - 186.



Ratings	Product
Switch Rated	DSN
	DS
	DB
Current Interrupting Rated	DXN
	Multipin
	DR
	PN
	DX, Competitors Pin and Sleeve
Non-Current Interrupting Rated	Multipin
	PF/PFQ
	Competitors Pin and Sleeve

# Electrical Performance

## Overload Conditions

UL & CSA standards for plugs and receptacles require that the devices be able to withstand overload conditions. General use conditions are simulated by testing a device to a specified number of operations (50) at 150% of rated current and a power factor between 0.75 and 0.80. Switch rated plugs and receptacles that are horsepower rated must perform overload testing at 600% of full load motor current with a more severe power factor (between 0.40 and 0.50) to simulate locked rotor conditions.

### UL & CSA Standards – Overload Test Requirements and Ratings Comparisons

Test	UL 1682 & CSA 22.2 No. 182.1		UL Subject 2682 (used for both UL & CSA listings)
	Plugs, Receptacles & Cable Connectors of the Pin & Sleeve Type		Switch Rated Plugs & Receptacles
	Non-Current Interrupting (Typical)	Current Interrupting (Typical)	Motor / Branch Circuit Switch Rated (Typical)
Overload (General Use Devices)	3 Operations @ 150% of Rated Current (p.f. = .75 - .80)	50 Operations @ 150% of Rated Current (p.f. = .75 - .80)	50 Operations @ 150% of Rated Current (p.f. = .75 - .80)
Overload - Locked Rotor (Horsepower Rated Devices)	-	-	50 Operations @ 600% of Full Load Motor Current (p.f. = .40 - .50)

### Test Results: Completed Operations at Overload/Locked Rotor Condition

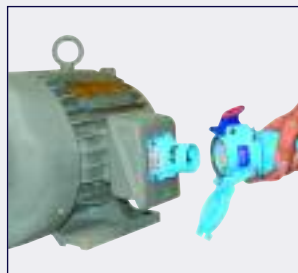
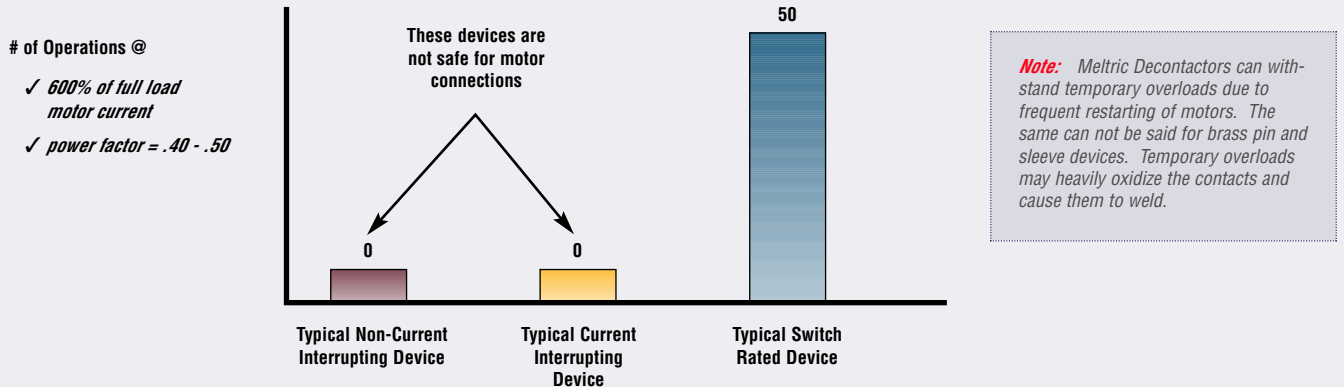

Motors and other equipment can be quickly and safely connected or disconnected with Meltric's Switch Rated DECONTACTOR™ Series plug and receptacles.

# Electrical Performance

## Mechanical and Electrical Endurance

UL and CSA standards require endurance testing to ensure that rated performance is maintained over the expected life of the device. The severity of this testing depends on the rating of the device.

As shown in the chart below, non-current interrupting devices are tested only for mechanical endurance. Current interrupting devices are additionally subjected to moderate electrical endurance testing, and switch rated devices are subjected to a much more severe level of electrical endurance testing, which is similar to that required of disconnect switches. In this regard, switch rated devices may be required to make and break under full load more than 20 times as many operations (depending upon device amperage) as a current interrupting rated pin and sleeve device.

### UL & CSA Standards – Endurance Test Requirements and Ratings Comparisons

Test	UL 1682 & CSA 22.2 No. 182.1		UL Subject 2682 (used for both UL & CSA listings)
	Plugs, Receptacles & Cable Connectors of the Pin & Sleeve Type		Switch Rated Plugs & Receptacles
	Non-Current Interrupting	Current Interrupting	Motor / Branch Circuit Switch Rated
Mechanical Endurance (no load)	15-20A = 5000 Operations 21-63A = 2000 Operations 64-250A = 250 Operations	15-20A = 0 Operations 21-63A = 1000 Operations 64-250A = 500 Operations	6000 Operations (Covered by Electrical Endurance testing)
Electrical Endurance (With Load)	-	15-20A = 5000 Operations 21-63A = 1000 Operations <sup>1</sup> 64-250A = 250 Operations <sup>1</sup> @ Rated Current & Voltage (p.f. = .75 - .80)	6000 Operations @ Rated Current & Voltage (p.f. = .75 - .80)

**Notes:** <sup>1</sup> Testing alternates between mechanical & electrical operations. This reduces the severity of the electrical test by allowing additional cooling time during electrical testing.

### Electrical Endurance Test Comparison

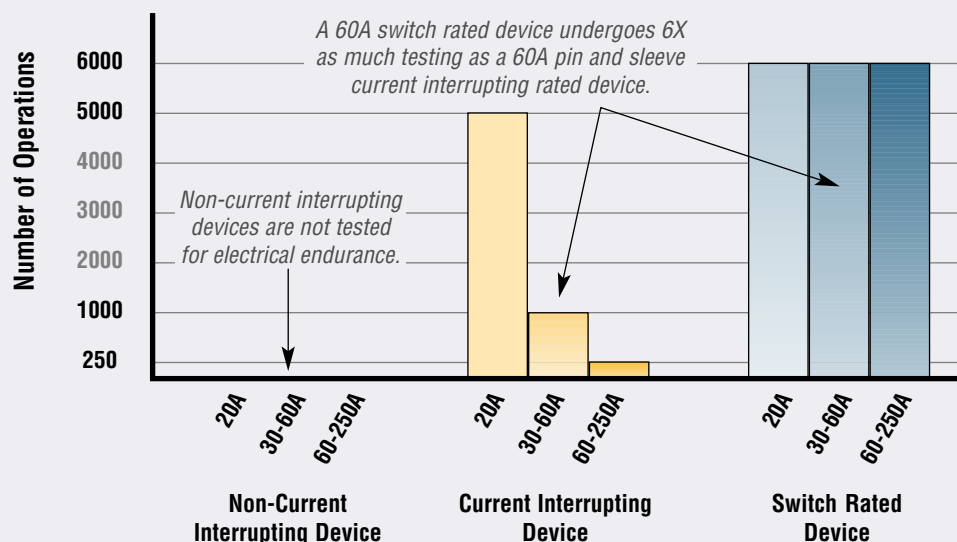

# Electrical Performance

## Short Circuit Protection

Meltric's Decontactors (DS, DSN, and DB products) have successfully completed high fault current short circuit testing. All these devices have short circuit make (close) and withstand ratings of either 65 kA or 100 kA. UL witnessed and approved this testing.

### UL Recognized Short Circuit Capabilities

UL Recognized Short Circuit Capabilities			
Plug & Receptacle Type	Short Circuit Ratings Product		Standard
	Withstand	Make	
General Use Pin & Sleeve Devices	None	None	UL 1682
HP Rated Twist-Type Devices	1kA	None	UL 498
Motor Rated Pin & Sleeve Devices	10kA	None	UL 1682
<b>Meltric Decontactors</b>	<b>≥ 65kA</b>	<b>≥ 65kA</b>	<b>UL Subject 2682</b>

### Short Circuit Test Information

#### Fusing

The amperage and time delay characteristics of the fusing used in testing affects the electrical load seen by the device. UL Subject 2682 requires short circuit tests be performed with fuses having an amperage rating that is no less than 400% of full load motor ampacity for horsepower rated devices, or no less than 100% of the device's amperage rating for general use devices.

Meltric used RK1 non-time delay type fusing for the horsepower rated devices because it is a common type of fuse used in motor applications. Meltric selected RK5 Time Delay fusing for the non-horsepower rated devices (DS9 & DS2) because it represents the most severe case of the various fusing scenarios that are typically used for general use applications.

#### Power Factor

The lower the power factor (p.f.) the more rigorous the test. UL Subject 2682 requires short circuit testing at 42,000 amps and above to be performed with a p.f. of 0.15 or less. By comparison, the p.f. for the 10,000 amp short circuit withstand test required by UL 1682 for horsepower rated plugs & receptacles, is a much less rigorous 0.50.

### Short Circuit Test Summary Table

Device Information			Short Circuit Make & Withstand Rating <sup>1</sup>			
Model	General Use Rating	Max Motor FLA <sup>1</sup>	kA	VAC	Fusing used in Testing	
DSN20	20A	8A (2 hp @ 208 VAC)	100	480	RK1	35A
DSN30	30A	18A (15 hp @ 600 VAC)	100	600	RK1	125A
DSN60	60A	27A (20 hp @ 480 VAC)	100	600	RK1	110A
DS20	20A	11A (3 hp @ 208 VAC)	100	600	RK1	80A
DS30	30A	14A (10 hp @ 480 VAC)	100	600	RK1	125A
DS60	60A	27A (25 hp @ 600 VAC)	100	600	RK1	250A
DS100C	100A	27A (25 hp @ 600 VAC)	100	600	RK1	250A
DS100	100A	-	65	600	RK5 TD	100A
DS200	200A	-	65	600	RK5 TD	200A
DB30	30A	26A (7.5 hp @ 208 VAC)	100	600	RK1	125A
DB60	60A	49A (15 hp @ 208 VAC)	100	600	RK1	250A
DB100	100A	92A (30 hp @ 208 VAC)	100*	600	RK1	250A*

<sup>1</sup> The maximum associated with any of the devices horsepower ratings. The fusing used in the short circuit testing must be at least 400% of this value in order for the short circuit rating to apply to the hp rating.

\* The fusing used limits the 100kA rating to 60hp @ 600V, 40hp @ 480V, 20hp @ 240V & 208V

# Technical Manual

## Contact Technology

Meltric products feature silver-nickel, spring-loaded butt contacts similar to those used in motor starters and contactors.

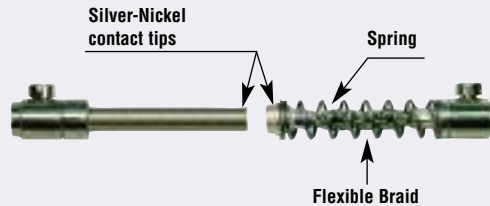

### Silver-Nickel Contact Material

Meltric uses solid silver-nickel (85%/15%) contacts. The silver-nickel material has significant advantages over the brass contacts commonly used on competitive devices.

Silver has very low initial contact resistance and is not negatively affected by oxidation. This helps to give it excellent electrical properties that are maintained even at high temperatures and after tarnishing. Nickel is a much harder material and contributes excellent mechanical properties. The combination of silver and nickel results in a contact material that has both superior electrical capabilities and excellent resistance to wear. Silver-nickel only welds at extremely high pressure and temperature, and thus, also withstands arcs very well. These features make silver-nickel a commonly used contact material by switchgear manufacturers.

By contrast, the brass material used in most competitive plugs and receptacles has much higher initial contact resistance and is negatively affected by oxidation. In an oxidized state, the contact resistance of brass is more than 20 times higher than that of silver-nickel. In addition, brass is a soft material that wears rapidly. In use, brass pin and sleeve and arcuate contacts suffer from the combined effects of the limitations of the material and the design. As oxidation and wear induced reductions in contact force occur, contact resistance increases. This increases operating temperature, which causes further oxidation and wear, perpetuating a vicious cycle of degradation. Brass is not arc resistant and is not suitable for making and breaking under load.

MATERIAL	CONTACT RESISTANCE	
	New	Oxidized
SILVER	6 $\mu\Omega$	25 $\mu\Omega$
SILVER-NICKEL	23 $\mu\Omega$	60 $\mu\Omega$
COPPER	29 $\mu\Omega$	400 $\mu\Omega$
BRASS	370 $\mu\Omega$	1400 $\mu\Omega$

*In an oxidized state, silver-nickel is 20 times more conductive than brass.*

### Spring-Loaded Contacts

Spring-loading of the contacts ensures that optimal pressure between the contacts is maintained – even after tens of thousands of operations. This point is important because contact force is a key determinant of the quality of the connection. As the accompanying graph demonstrates, contact resistance increases as contact force decreases. Higher contact resistance generates more heat and oxidation, both of which contribute to the deterioration of the contact. This is a problem with pin and sleeve and arcuate type contacts because their contact force varies with manufacturing tolerances and is reduced due to wear that occurs with normal use.

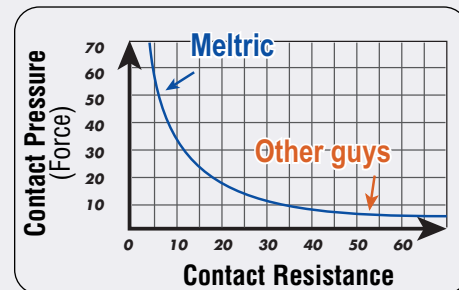

*Higher contact pressure leads to lower contact resistance.*

### Butt-Style Connection

Meltric's butt-style contact configuration provides a positive and secure connection and also makes connection and disconnection easy. With butt contacts, the force applied to the contacts is in-line with the insertion motion, so inserting a plug into it's socket requires only a known and limited amount of effort. Contact wear and sensitivity to manufacturing tolerances is negligible, because the spring-loading is sufficient to compensate for minor differences in contact length.

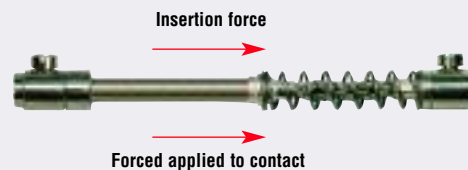

*With Meltric's butt contacts the force applied to the contacts is in-line with the insertion motion.*

With the pin and sleeve design used by our competitors, the contact force is at a right angle to the insertion/withdrawal force. There are numerous drawbacks to such a design:

- ▼ The contact pressure must be sufficient to prevent excessive temperature rise but is limited by the need to keep the insertion force reasonable.
- ▼ The necessary friction wears out the contacts, and diminishes contact pressure over time.
- ▼ Normal manufacturing tolerances result in wide variations in performance, even with new devices.
- ▼ The sliding contact design does not make & break cleanly, so arcing is more likely to occur.

### Quick Break Mechanism

On most Meltric devices, the circuit is broken simply by depressing the pawl. Doing so releases the energy in a spring-loaded operating mechanism, which instantaneously breaks the circuit and ejects the plug to the 'OFF' position. Contact breaking time is about 15 milliseconds. The quick break mechanism is automatically reloaded when the plug is re-inserted.

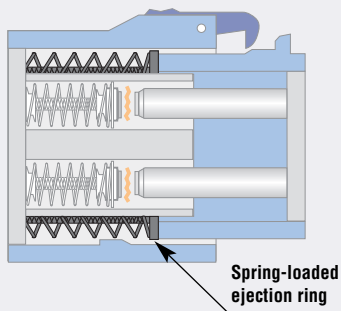

Spring-loaded ejection system ensures a quick break of the contacts.

In contrast, the disconnection speed of pin and sleeve and twist type devices is dependent on the users motion when removing the plug.

### Self Cleaning System

Meltric contacts close with a self-cleaning, wiping action. When the contacts initially mate, they are slightly offset. In completing the connection, the plug contacts are rotated partially across the receptacle contacts, helping to remove deposits from the contact surface.

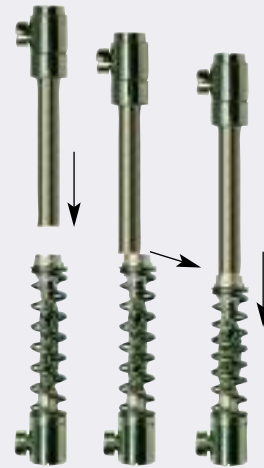

Meltric contacts are self cleaning.

### Contact Mating Sequence

Decontactor contacts mate in a specific sequence to ensure a proper and safe connection.

1. The earth (ground) closes first
2. Then the neutral,
3. Then the phases,
4. Then the auxiliary contacts, if any. These auxiliary contacts can, therefore, be used as "pilot" contacts.

On opening, the sequence is reversed.

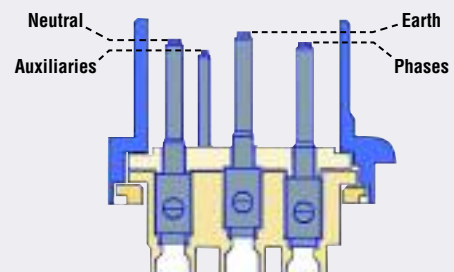

The contacts are set in the plug at different levels to achieve the desired mating sequence.



# Technical Manual

## Dead Front and Enclosed Arc Chambers For Maximum Protection from Live Parts

Most Meltric receptacles feature a dead front which encloses and isolates the live contacts when the plug is removed. Only electrically compatible plugs can unlock the safety shutter and gain access to the live parts. In addition to preventing accidental exposure to live parts, the safety shutter also keeps the contacts clean and out of reach even if the lid is left open.

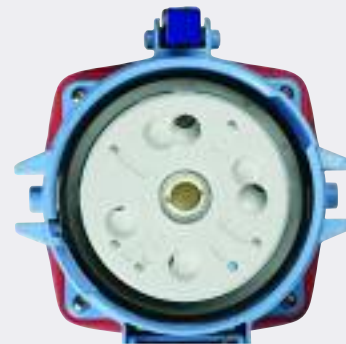

The receptacle's dead front protects workers from accidental tool and wire insertion.

### Protection During the Making and Breaking Process

When disconnecting or connecting a Meltric plug from/to a receptacle, the user is completely protected from exposure to arc flash or live parts. This is because the contacts can only make or break while they are enclosed in internal arc chambers within the receptacle.

During disconnection, the pressing of the pawl on the receptacle breaks the connection (inside the arc chambers) and ejects the plug to its rest or "OFF" position. While in the rest position, the plug and receptacle casings maintain a dead front and thus protect the user from live parts. The plug can not be fully withdrawn until it is rotated 30° counterclockwise. This closes and locks the safety shutter preventing access to live parts during and after the removal of the plug.

During connection, the plug contacts can only access the receptacle contacts after the plug has been partially inserted into the receptacle and has then been rotated 30° to open the safety shutter. Because the interaction of the skirted plug casing with the receptacle forms a protective enclosure that prevents access to the contacts as soon as insertion begins, a dead front is maintained even after the safety shutter is opened. Once the safety shutter has been opened, can the plug contacts be safely inserted into the arc chambers where the connection is made as the plug is latched to the receptacle.

### Protection from Insertion of Inappropriate Plugs

Meltric products offer up to 24 different keying positions. Only plugs and receptacles that are keyed/notched in the same positions will mate with each other. Non-compatible plugs will be unable to open the safety shutter. This system prevents potentially dangerous situations. For example, a 250V plug (notch 16) can not be inserted into a 480V receptacle (notch 04). Alternatively, on the PF and DX series, pegs and holes perform the same function as the notches.

**Note:** *Coding Disk* Some receptacles utilize a coding disk which performs the same functions as does the one piece safety shutter.

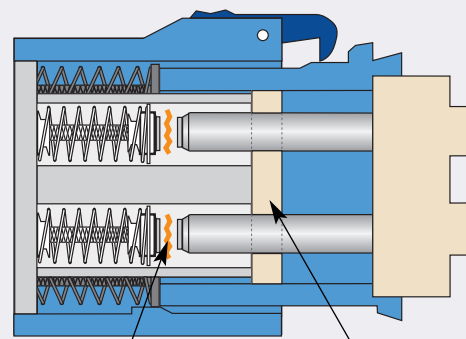

Arc chamber prevents outside exposure to arc flash.

Safety shutter prevents finger or tool access to live parts.

**Note:** *Some of the keying positions have been assigned to a designated global voltage. A few others are unassigned and are available if a user prefers to limit mating of plugs and receptacles that are only to be used on particular applications.*

## Commonly Used Keying Positions

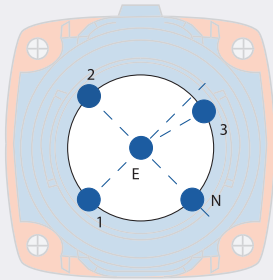

**Position 04**  
255-277V/440-480V 60Hz

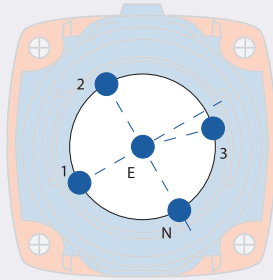

**Position 07**  
110-125/220-250V 50Hz

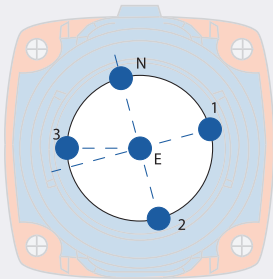

**Position 14**  
347/600V 60Hz

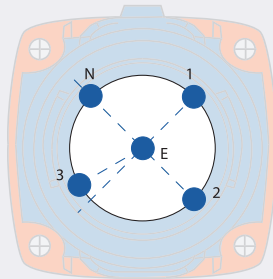

**Position 16**  
120-127V/208-220V 60Hz

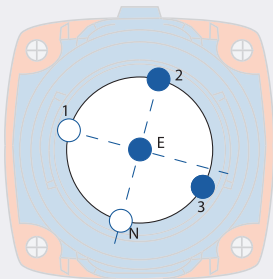

**Position 02**  
20-24V DC

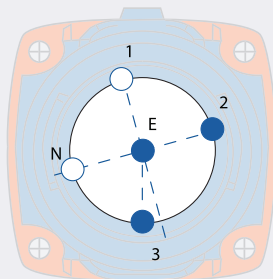

**Position 20**  
220-250V DC

*Note:* See chart on page 13 for a complete list of voltage polarization positions and associated voltages.

## How to Identify Keying Positions of an Existing Device

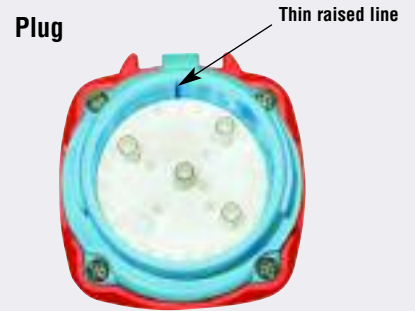

The keying position of most Meltric plugs can be determined by looking at the plug interior and finding a thin, raised line in the casing. This line is always directly above a number that identifies the plug's keying position.

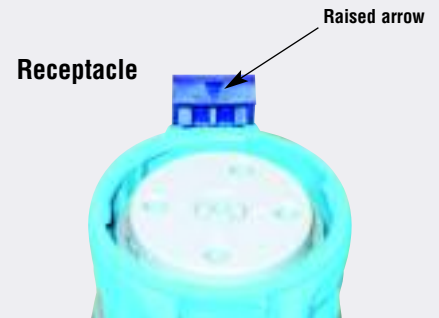

The keying position for most receptacles can be determined by identifying a raised arrowhead (usually on the pawl or on the casing next to the pawl). This arrow points to a key number that can be found on the ring that surrounds the safety shutter.

## Dual Voltage Devices Maximize User Flexibility

Some Meltric receptacles are designed to safely allow dual voltage capabilities.

For example, a 208V rated 3P+N+E receptacle will safely provide power to several configurations of 208V plugs and a single phase 120V plug. Having two voltages delivered by a single receptacle allows some facilities to significantly reduce the number of receptacles that need to be installed.

Dual voltage receptacles are supplied with dual color coded voltage stickers.

## Dual Voltages Typically Available from Meltric

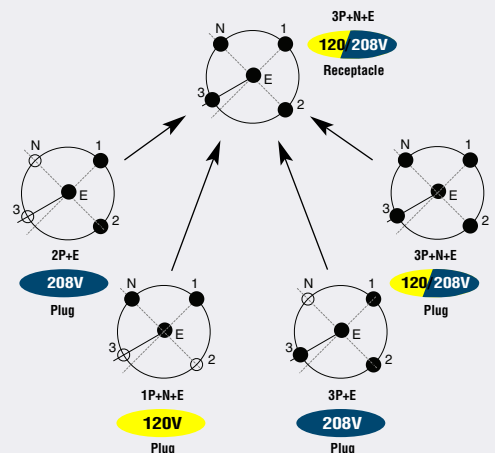
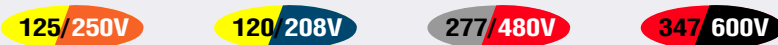

# Device Materials and their Resistance to Environments and Chemicals

## Polymeric Materials

**Casings** – The common technical name for the “Poly” material used by Meltric is PBT or PBTP (Poly Butylene Tere Phthalate). It consists of a special blend of thermoplastic polyester, fiberglass and elastomers which provides outstanding resistance to most chemical agents and environmental conditions, including UV and gamma rays. This material also offers high impact resistance across a broad spectrum of temperatures (shock resistance ratings to IK08).

**Interiors** – The arc chambers for most Meltric devices are made of Melamine or of a special compound of thermoplastic polyester, fiberglass, and elastomer. Other materials are used such as Polyamide and Bakelite.

**Accessories** – Handles, angles and wall boxes are made of Polyamide (they are supplied with self tapping screws).

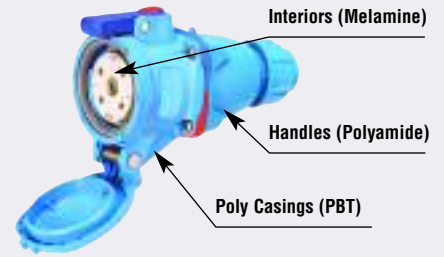

Products with Poly (PBT) casings
DSN20, DSN30, DSN60
DS20, DS30, DS60, DS100, DS100C
DR30, DR50, DR100, DR150
DXN20, DXN30, DXN60
DSN24, DSN37, DS7, DR7

## Resistance of Polymeric Casings to Various Chemical Agents

Agent	Polyester reinforced glass fiber			Polyamide		
	23°C	60°C	80°C	23°C	60°C	80°C
Butyl acetate	☆☆	☆☆		☆☆		
Ethyl acetate	☆			☆☆		
Acetone	☆			☆☆		
Acetic acid	5%	☆☆	☆☆	☆	☆	-
	10%	☆☆	☆	☆	-	-
Hydrochloric acid	10%	☆☆	☆☆	☆☆	☆	-
Chromic acid	40%	☆☆	☆☆	☆☆	-	-
Citric acid	10%	☆☆	☆☆	☆☆	☆	
Formic acid	5%	☆☆	☆	☆☆	☆	
Nitric acid	10%	☆☆	☆	☆☆	☆	-
Oleic acid	100%	☆☆	☆☆	☆☆	☆☆	☆☆
Phosphoric acid	3%	☆☆	☆☆	☆☆	☆☆	☆☆
	30%	☆☆	☆☆	☆☆	☆☆	☆☆
	85% (conc)	☆☆	☆☆	☆☆	-	-
Sulphuric acid	3%	☆☆	☆☆	☆☆	-	-
	30%	☆☆	☆☆	☆☆	-	-
Ethyl alcohol		☆☆		☆☆		
Methyl alcohol		☆☆		☆☆		
Aniline		☆☆		-		
Benzene		☆	☆	☆☆		
Soda Bicarbonate	10%	☆☆	☆	-	☆☆	☆☆
Potassium bichromate	10%	☆☆			☆☆	☆☆
Sodium bisulphate	10%	☆☆	☆	-	☆☆	☆☆
Butane		☆☆		☆☆		
Butanol		☆	☆	☆☆		
Soda carbonate	10%	☆☆	-	-	☆☆	☆☆
	20%	☆☆	-	-	☆☆	☆☆
Disulphuric carbonate		☆☆		☆☆		
Calcium chloride	10%	☆☆	☆☆		☆☆	
Potassium chloride	10%	☆☆	☆	-	☆☆	
Sodium chloride	10%	☆☆	☆	-	☆☆	
Detergents	1%	☆☆	☆	-	☆☆	☆☆
	25%	☆☆	☆	-	☆☆	☆☆
Dibutylphthalate		☆☆	☆☆		☆☆	
Dichlorethane		-		☆☆		
Dioxane		☆☆	-	☆☆		
Water		☆☆	☆☆	-	☆☆	☆☆
Bleach		☆☆	☆☆		☆☆	
Gas		☆☆		☆☆		
Turpentine		☆☆		☆☆		

Agent	Polyester reinforced glass fiber			Polyamide		
	23°C	60°C	80°C	23°C	60°C	80°C
White spirit	☆☆			☆☆		
Ether	☆☆			☆☆		
Freon 11	☆☆			☆☆		
Glycerine	☆	☆		☆☆	☆	-
Glycol	☆	☆		☆☆	☆	-
Grease	☆☆	☆☆	☆☆	☆☆	☆☆	☆☆
Heptane	☆☆			☆☆		
Hexane	☆☆			☆☆		
Cotton seed oil	☆☆	☆☆	☆☆	☆☆	☆☆	☆☆
Silicon oil	☆☆	☆☆	☆☆	☆☆	☆☆	☆☆
Processing oil	☆☆	☆☆	☆☆	☆☆	☆☆	☆☆
Diesel oil	☆☆			☆☆		
Olive oil	☆☆	☆☆	☆☆	☆☆	☆☆	☆☆
Mineral oil	☆☆	☆☆	☆☆	☆☆	☆☆	☆☆
Engine oil	☆☆	☆☆	☆☆	☆☆	☆☆	☆☆
Plant oil	☆☆	☆☆	☆☆	☆☆	☆☆	☆☆
Ammonium hydroxide	10%	☆		☆☆		
	conc	-		☆☆		
Potassium hydroxide	1%	-	-	☆☆		
	10%	-	-	☆☆		
Sodium hydroxide	1%	-	-	☆☆		
	10%	-	-	☆☆		
Calcium hypochlorite		☆☆	☆☆	☆☆		
Sodium hypochlorite	10%	☆☆	☆	-	-	-
Isopropanol		☆	☆		☆☆	
Braking liquid		☆☆	☆☆	☆☆	☆☆	
Methylethycetone		☆☆	☆☆	☆☆	☆☆	
Perchloroethylene		☆☆	☆☆	☆☆	☆☆	
Potassium permanganate	10%	☆☆			☆☆	
Oil		-		-		
Hydrogen peroxide	3%	☆☆			☆☆	
	30%	☆☆			☆☆	
Soap solution	1%	☆☆	-	-	☆☆	
Carbon tetrachloride		☆☆			☆☆	
Tetrahydrofurane		☆			☆☆	
Toluene		☆☆			☆☆	
Trichlorethylene		☆☆			☆☆	☆☆
Vaseline		☆☆	☆☆	☆☆	☆☆	☆☆
Xylene		☆☆			☆☆	

Legend: ☆☆☆ = Excellent ☆ = Good - = Poor

## Metal Materials

**Casings** – Metal casings providing even greater impact resistance are standard on some Meltric products and are optional on others. Depending upon the product line, these casings may be made of zamak, aluminum or stainless steel. Zamak, a zinc - aluminum alloy is the most commonly used. Zamak receptacles are blue epoxy coated and zamak plugs are specially treated to further improve corrosion resistance.

**Contacts** – All Meltric contact surfaces are made of solid silver-nickel with the exception of the PF and PFQ contacts which are solid pure silver. Silver-nickel and silver both provide excellent resistance to climatic conditions and to all known chemical agents found in industry with the exception of sulphuric acid. Products installed in sulphuric acid environments should have an environmental rating of at least NEMA 4X or IP 66.

**Accessories** – Wall boxes, angles, and handles are in zamak or aluminum alloy. All zamak accessories are standardly protected by an epoxy paint.

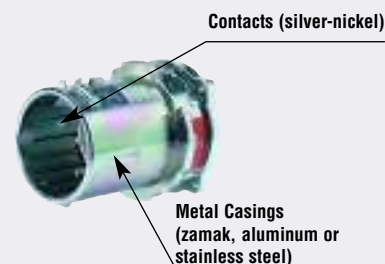

### Products with Metal Zamak casings:

DS60, DS100C, DS100, DS200

DB30, DB60, DB100

DR100, DR150, DR250

PN7, PN12, DN7, DN20, DS7, DR7

### Products with Aluminum Casings

PN (HT)

DX20, DX30, DX60, DX100

PFQ300, PF300, PF400, PF600

### Products with Stainless Steel Casings

PN12

DS24, DS37

*Contact customer service for availability of Stainless Steel on other products*

## Resistance of Metal Casings to Corrosive Agents

Agent	Protected Zamak or Aluminum
Dry lighting gas	☆☆
Water steam	☆
Hot water	☆
Artificial sea water	☆
Soluble oil 3%	☆
Soluble oil 5%	☆☆
Cleansing soap	☆☆
Potash solution 1%	☆
Potash solution 5%	☆
Ammonia 1%	☆
Ammonia 5%	☆
Sodium chloride 1%	☆
Sodium chloride 5%	☆
Acetic acid 1%	☆
Acetic acid 5%	–
Gas	☆☆
Engine oil	☆☆
Printing ink	☆
Ethyl or methyl alcohol	☆☆
Trichloethylene	☆
Dry insecticides	☆

Legend: ☆☆ = Excellent ☆ = Good – = Poor

# Technical Manual

## Watertightness / Ingress Protection (NEMA and IP ratings)

### Environmental Ratings for Meltric Devices



Most Meltric products achieve rated watertightness as soon as the plug is fully inserted into the receptacle. The primary exception is the DB product line which requires the turning of a locking ring.

Product	NEMA	IP (plug + receptacle)	IP (receptacle alone)
DSN	4X	66+67	66+67
DS+	3R	54	55
DB	-	67	67
DXN	4X	66+67	66+67
DX	-	65	65
DN	-	54	55
PF/PFQ	-	66+67	66+67
DR+	3R	54	55
PN	4X	66+67	66+67
SP	-	66+67	66+67

\* Additional watertightness is available on DS and DR devices, see pg 174

### Environmental Ratings Explained:

#### NEMA/UL/CSA Enclosure Types (UL50)

NEMA Enclosure Type	Intended Use and Description
1	Indoor use primarily to provide a degree of protection against limited amounts of falling dirt
2	Indoor use primarily to provide a degree of protection against limited amounts of waste and falling dirt
3, 3R, 3S	Outdoor use primarily to provide a degree of protection against rain, sleet, and damage from external ice formation.
4, 4X	Indoor or outdoor use primarily to provide a degree of protection against windblown dust and rain, splashing water, hose-directed water, and damage from external ice formation
12	Indoor use primarily to provide a degree of protection against circulating dust, falling dirt and dripping non-corrosive liquids

#### IP Ratings (IEC/EN 60529)

First Digit		Second Digit	
Protection against the ingress of solid foreign objects and access to hazardous parts		Protection against the ingress of water with harmful effects	
0	No protection	0	No protection
1	50mm Back of hand	1	Vertically dripping water (condensation)
2	12.5mm Finger	2	Dripping water at 15°
3	2.5mm Tool	3	Spraying water at 60° (rain)
4	1mm Wire	4	Splashing water from any direction
5	Against Dust -	5	Jetting water from any direction
6	Dust-tight -	6	Powerful jetting water from any direction
-		7	Temporary submersion

# Impact Resistance

Meltric product resistance to mechanical shocks is specified in accordance with their IK ratings.

## Meltric Products IK Ratings (per IEC/EN 50102)

Product	Material	IK Rating
DSN	Poly	08 (5 Joules)
DS	Poly	08 (5 Joules)
DS	Metal	09 (10 Joules)
DB	Metal	09 (10 Joules)
DR	Poly	08 (5 Joules)
DR	Metal	09 (10 Joules)
DN	Metal	09 (10 Joules)
PN	Poly	08 (5 Joules)
PN	Metal	09 (10 Joules)
PF	Metal	10 (20 Joules)
DX	Metal	10 (20 Joules)
DXN	Poly	08 (5 Joules)



# Operating Temperatures

All Meltric plugs and receptacles can be used with no particular precaution from -15°F to 140°F/-26°C to 60°C.

## Hot Temperatures

Some devices that do not contain any polyamide can operate up to 175°F/80°C but precise conditions and duty cycles must be submitted to the Meltric engineering department for approval. A limited range of products are available for ambient temperatures up to 365°F/185°C. Contact Meltric customer service for more information.

## Cold Temperatures

Below -15°F materials become more brittle and impact should be avoided, especially on polyamide materials. However, Meltric's metal and polyester casings can be used as low as -40°F/-40°C and some Meltric devices are in service at -75°F/-60°C. Consult factory for more information.

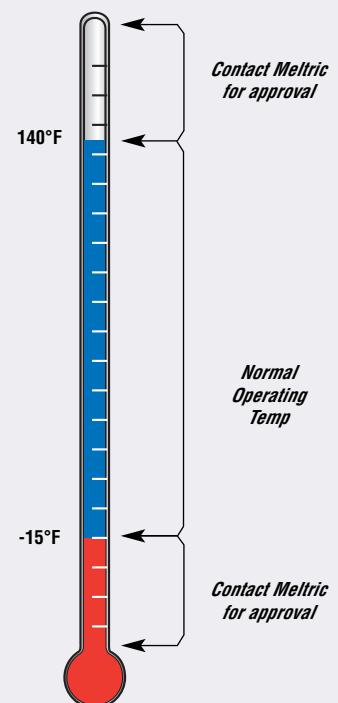

# Color Coded Gaskets & Labels For Voltage Identification

PIN CONFIGURATION	VOLTAGE	FREQUENCY	5 <sup>th</sup> , 6 <sup>th</sup> and 7 <sup>th</sup> PART NUMBER DIGITS	RECEPTACLE/CONNECTOR		PLUG/INLET	
				COLOR GASKET	VOLTAGE STICKER	COLOR GASKET	VOLTAGE STICKER
1P+N+E	110/130V	50Hz	035	YELLOW	YELLOW	YELLOW	YELLOW
	115/127V	200Hz	125	GREEN	YELLOW	GREEN	YELLOW
	115/127V	400Hz	115	GREEN	YELLOW	GREEN	YELLOW
	120/127V	60Hz	165	YELLOW	YELLOW	YELLOW	YELLOW
	110/125V	60Hz	075	ORANGE	ORANGE	ORANGE	ORANGE
	220/250V	50Hz	015	BLUE	BLUE	BLUE	BLUE
	255/277V	60Hz	045	GREY	GREY	GREY	GREY
	347V	60Hz	145	RED	RED	RED	RED
	380/440V	50Hz	195	RED	RED	RED	RED
	577V	50Hz	225	BLACK	BLACK	BLACK	BLACK
2P	20/24V	50Hz	08A	VIOLET	VIOLET	VIOLET	VIOLET
	20/24V	60Hz	02A	VIOLET	VIOLET	VIOLET	VIOLET
	20/24V	DC	08Z	VIOLET	VIOLET	VIOLET	VIOLET
	25/28V	50Hz	06A	SKY BLUE	SKY BLUE	SKY BLUE	SKY BLUE
	25/28V	DC	06Z	SKY BLUE	SKY BLUE	SKY BLUE	SKY BLUE
	40/48V	DC	13Z	WHITE	WHITE	WHITE	WHITE
	40/48V	50Hz	13A	WHITE	WHITE	WHITE	WHITE
2P+E	110/130V	DC	109	YELLOW	YELLOW	YELLOW	YELLOW
	200/220V	200Hz	122	GREEN	BLUE	GREEN	BLUE
	200/220V	400Hz	112	GREEN	BLUE	GREEN	BLUE
	208/220V	60Hz	162	BLUE	BLUE	BLUE	BLUE
	220/250V	50Hz	032	BLUE	BLUE	BLUE	BLUE
	220/250V	DC	209	BLUE	BLUE	BLUE	BLUE
	220/250V	60Hz	072	ORANGE	ORANGE	ORANGE	ORANGE
	380/440V	50Hz	012	RED	RED	RED	RED
	440/480V	60Hz	042	RED	RED	RED	RED
	480/500V	50Hz	092	BLACK	BLACK	BLACK	BLACK
	600V	60Hz	142	BLACK	BLACK	BLACK	BLACK
	660/690V	50Hz	192	BLACK	BLACK	BLACK	BLACK
	1000V	50Hz	222	BLACK	BLACK	BLACK	BLACK

PIN CONFIGURATION	VOLTAGE	FREQUENCY	5 <sup>th</sup> , 6 <sup>th</sup> and 7 <sup>th</sup> PART NUMBER DIGITS	RECEPTACLE/CONNECTOR		PLUG/INLET	
				COLOR GASKET	VOLTAGE STICKER	COLOR GASKET	VOLTAGE STICKER
2P+N+E	115 / 127V 200 / 220V	200Hz	126	GREEN	YELLOW BLUE	GREEN	YELLOW BLUE
	115 / 127V 200 / 220V	400Hz	116	GREEN	YELLOW BLUE	GREEN	YELLOW BLUE
	120 / 127V 208 / 220V	60Hz	166	BLUE	YELLOW BLUE	BLUE	YELLOW BLUE
	110 / 130V 190 / 230V	50Hz	036	BLUE	YELLOW BLUE	BLUE	YELLOW BLUE
	110 / 125V 220 / 250V	60Hz	076	ORANGE	ORANGE	ORANGE	ORANGE
	220 / 250V 380 / 440V	50Hz	016	RED	BLUE RED	RED	BLUE RED
	255 / 277V 440 / 480V	60Hz	046	RED	RED	RED	RED
	480/500V	50Hz	096	BLACK	BLACK	BLACK	BLACK
	347/600V	60Hz	146	BLACK	RED BLACK	BLACK	RED BLACK
	380 / 400V 660 / 690V	50Hz	196	BLACK	RED BLACK	BLACK	RED BLACK
3P+E	200/220V	200Hz	123	GREEN	BLUE	GREEN	BLUE
	200/220V	400Hz	113	GREEN	BLUE	GREEN	BLUE
	208/220V	60Hz	163	BLUE	BLUE	BLUE	BLUE
	220/250V	50Hz	033	BLUE	BLUE	BLUE	BLUE
	220/250V	60Hz	073	ORANGE	ORANGE	ORANGE	ORANGE
	380/440V	50Hz	013	RED	RED	RED	RED
	440/480V	60Hz	043	RED	RED	RED	RED
	480/500V	50Hz	093	BLACK	BLACK	BLACK	BLACK
	600V	60Hz	143	BLACK	BLACK	BLACK	BLACK
	660/690V	50Hz	193	BLACK	BLACK	BLACK	BLACK
1000V	50Hz	223	BLACK	BLACK	BLACK	BLACK	
3P+N+E	110 / 130V 220 / 250V	50Hz	037	BLUE	YELLOW BLUE	BLUE	YELLOW BLUE
	115 / 127V 200 / 220V	200Hz	127	GREEN	YELLOW BLUE	GREEN	YELLOW BLUE
	115 / 127V 200 / 220V	400Hz	117	GREEN	YELLOW BLUE	GREEN	YELLOW BLUE
	120 / 127V 208 / 220V	60Hz	167	BLUE	YELLOW BLUE	BLUE	YELLOW BLUE
	110 / 125V 220 / 250V	60Hz	077	ORANGE	ORANGE	ORANGE	ORANGE
	220 / 250V 380 / 440V	50Hz	017	RED	BLUE RED	RED	BLUE RED
	255 / 277V 440 / 480V	60Hz	047	RED	RED	RED	RED
	347/600V	60Hz	147	BLACK	RED BLACK	BLACK	RED BLACK
	380 / 400V 660 / 690V	50Hz	197	BLACK	RED BLACK	BLACK	RED BLACK
	MULTIPIN		NOT SPECIFIED		SKY BLUE	SKY BLUE	SKY BLUE